

Kährs®

QUALITY IN WOOD SINCE 1857

INSTALLATION GUIDE

KÄHRs FLOATING WOOD FLOORING WITH WOODLOC® 5S AND ACCESSORIES

CONTENT

WOODLOC® 5S PAGE 3

Introduction

The principle behind Woodloc® 5S

INSTALLATION REQUIREMENTS FOR WOOD FLOORS PAGE 4

General

General preparations

Installation instruction Woodloc® 5S

INSTALLING KÄHRS WOOD FLOORS OVER UNDERFLOOR HEATING PAGE 6

Installation

WHAT TO CONSIDER BEFORE INSTALLATION PAGE 7

Scheduling installation

Storage

Installing boards in patterns

Fixtures and fittings

Planning floor installation

Movement joints in wood floors

Uneven subfloors

Choice of laying direction, max. widths

Calculate the skirting board thickness

Cleaning the subfloor

WHAT TO CONSIDER WHEN INSTALLING PAGE 9

Temperature and humidity conditions

Opening packs

Inspection

End joints in small areas

Gluing joints

Pattern misalignments

Door openings

Fitting skirting boards

Bowing

WHAT TO CONSIDER AFTER INSTALLATION PAGE 10

Supplementary surface treatment

Protective covering

Tape

Ventilation

Colour changes

INSTALLATION AND FITTING INSTRUCTIONS PAGE 11

Installation instructions for vapour barriers and intermediate layers

Using tools and accessories

Installation instructions for Kährs wood floors with Woodloc® 5S joints

Installation instructions for Kährs 15mm on 150 kPa expanded foam (domestic)

Installation instructions for Kährs wood floor on 250 kPa expanded foam (public)

Fixing instructions for wood floor accessories

Instructions for supplementary products

KÄHRS POLICY ON FLAWS AND REJECTION OF MATERIAL DURING INSTALLATION PAGE 20

WOODLOC® 5S – THE 'NEXT GENERATION' INNOVATION

Kährs was the first company in the world to introduce a mechanical and glue-free joint system – Woodloc®. The benefits were clear: it was quick and easy to install, required no adhesive and it produced a perfect finish.

Now Kährs is introducing the next generation – Woodloc® 5S. This new system features a special locking tongue, allowing floors to be installed even quicker and providing a joint that is around 25% stronger than its predecessor. The new joint also allows up to a 75% larger area to be installed without an expansion joint.

Kährs floors with Woodloc® 5S can also be glued down onto concrete floors. Special installation instructions can be downloaded at www.kahrs.com

Component parts

1. Groove
2. Tongue
3. Locking strip
4. Locking element
5. Locking tongue

Figure A.

The principle behind Woodloc® 5S

Each board has a sliding locking tongue that is inset into a groove. When the short end of the locking tongue is edge to edge with the veneer surface, the joint is in the unlocked position. Figure B, C.

This means that the row of teeth in the adjacent board will be in the correct position when joining the planks together, allowing the joint to lock. The locking of the joint should always be done using the Kährs Handblock. Figure D, E, F.

The locking of the joint should always be done using the Kährs Handblock. Locking of the last row shall be done using the Kährs locking tool.

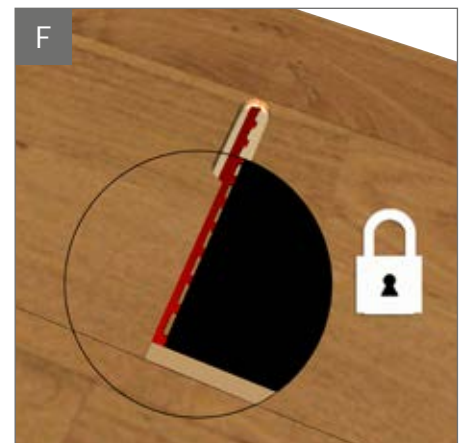
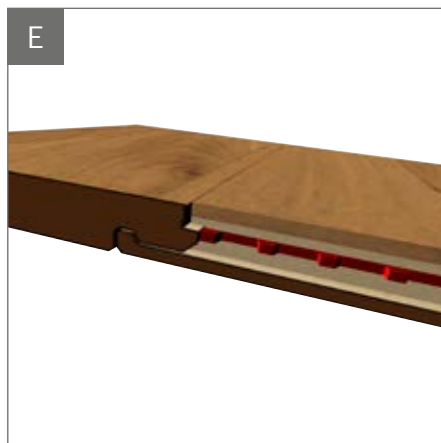
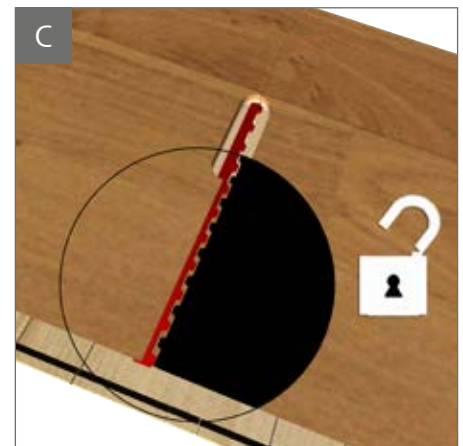
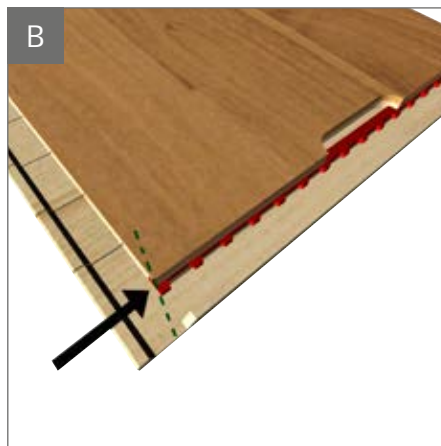
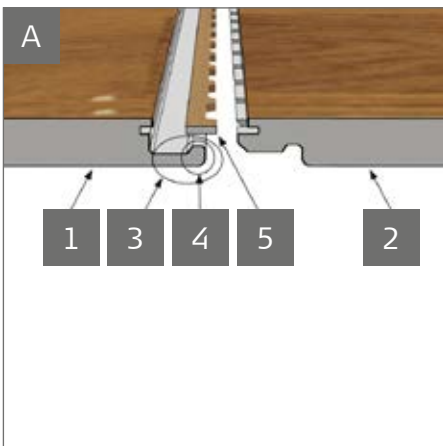

INSTALLATION REQUIREMENTS FOR FLOATING WOOD FLOORS

General

Wood is hygroscopic, ie, it is a "living" material. Depending on the ambient air humidity and temperature, the material either emits or absorbs moisture. This is associated with a change of volume (swelling or shrinkage). It is therefore important that there is an "expansion gap" or "movement joint" in between the floor and the wall and other fixed objects when a wood floor is installed floating. To stop the floor absorbing moisture prior to installation, it is important not to open packaging until just before installation.

Many mistakes and damage to the floor can be avoided by studying the installation instructions before starting installation and then following them carefully.

Note that moisture levels in new build premises often remain relatively high by the time wood floors are installed.

To avoid damage, it is important that the relative humidity during and after installation is less than 60%. The temperature of rooms and materials must be at least 15°C. A wood floor must not therefore be installed until all other trades, such as painters and tilers, have finished their work and the site has the correct RH.

Moisture protection is not normally necessary on structural floors where the relative humidity is below 60%. Note that newly cast structural floors do not meet this requirement, so a moisture barrier is always needed.

A moisture barrier on the following subfloors, whatever their age, is obligatory for the reasons given below:

- concrete floor lying directly on the ground (ground-supported slab)
- floor above warm or humid area (e.g. boiler room or laundry room)
- structural floor above a ventilated crawl space foundation
- lightweight concrete floor structures
- underfloor heating

If the subfloor's relative humidity is higher than 90%, a plastic sheeting vapour barrier will not provide a sufficient moisture barrier.

Wood floors should always be laid staggered in every row, even in small areas such as hallways. Distributing the short ends evenly means that the floor will remain flat and level even during seasonal climate changes.

Kährs products and installation methods follow the guidelines set out in AMA Hus.
(in accordance with the Swedish Building Regulation System - AMA Hus.)

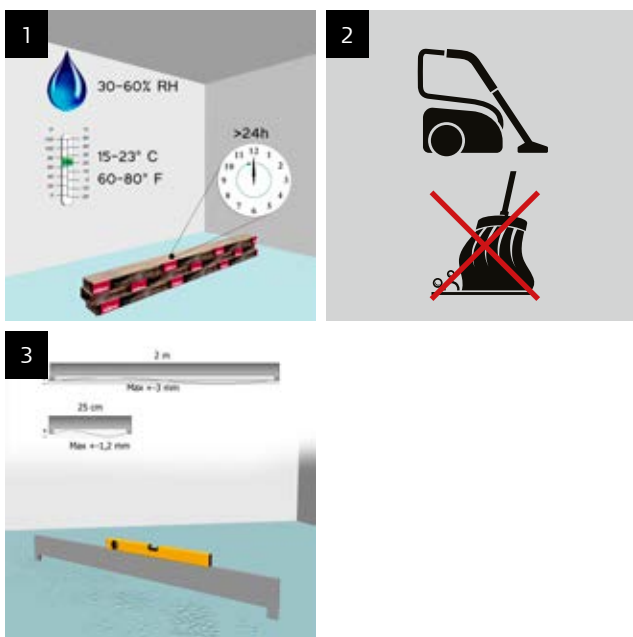

General preparations

- Store the floorboards in their packaging. *Figure 1.*
- Open the packs only when needed during installation.
- Read the installation instructions carefully before installing.
- The subfloor must be dry, level, clean and solid. *Figure 2.* Remove fitted carpets. For installing on foam (EPS), download our brochure *Subfloor Requirements and Underfloor Heating* at www.kahrs.com.
- Check that the subfloor is flat and level over measured lengths of 2 m and 0.25 m. If any unevenness exceeds ± 3 mm over 2 m or ± 1.2 mm over 0.25 m, the floor must be levelled first. Kährs also accepts a measured length of 1 m. The tolerance in this case is ± 2 mm. *Figure 3.*
- Check the humidity of the subfloor. Subfloors consisting of newly cast concrete joists or lightweight concrete joists, ground-supported concrete floors, above warm or humid areas, over crawl space foundations or over an underfloor heating system must first have age-resistant 0.2 mm polyethene (PE) sheeting laid to protect against moisture. Lay the sheeting with a min. overlap of 200 mm. The subfloor must be cleaned thoroughly to prevent mould. If the subfloor's relative humidity is higher than 90%, a plastic sheeting vapour barrier will not provide a sufficient moisture barrier. Before starting to install the floor, any moisture problems should be taken care of.

- The room's relative humidity shall be between 30–60% RH. The temperature of the room and the boards must reach at least 15°C. *Figure 1.*
- Where applicable, an intermediate layer can be laid on top of the sheeting to reduce impact noise. Use 2–3 mm polyethene foam in combination with the sheeting or use a combi product from the Kährs Underlayer Material range. Butt joint the edges of the intermediate layer. If an impact sound reduction is required, please contact an acoustics specialist.
- In narrow rooms, lay the boards in the long direction. The floor moves as the air humidity varies, and should therefore have a movement joint. For practical purposes, for floors < 6 m wide allowing a 10 mm movement joint next to walls and fixed objects (stairs, pillars, door frames, etc.) is convenient. For larger floor areas (> 6 m wide) allow 1.5 mm of movement joint per metre of floor width. This movement joint must run all round the floor. For 15 mm multi-layer flooring with Woodloc® 5S the maximum floor width is 25 m and for 13 mm multi-layer flooring it is 15 m.
- Put damaged or faulty boards to one side. They may be surplus or useful for finishing off. You can, of course, exchange any damaged boards where you purchased them.

If you make a mistake, boards with Woodloc® 5S can be taken up and re-laid quickly and easily, which simplifies the procedure. The Woodloc® 5S joint helps reduce errors during installation.

We recommend that you consult your floor supplier or ourselves regarding building moisture if you want to lay the floor on a construction other than those described in our brochure *Subfloor Requirements and Underfloor Heating*, if you want to lay a large floor or if anything else is unclear.

Installation instruction Woodloc® 5S

This document gives you basic information when installing a floating Kährs flooring product. If you require more detailed information concerning the installation or if you want to learn more about how to maintain your new floor, please visit www.kahrs.com where this and other important information is available. You can also see Kährs instruction videos here.

<http://www.kahrs.com/en-GB/consumer/Services-Downloads/Installation-Instructions/>

INSTALLING KÄHRS WOOD FLOORS OVER UNDERFLOOR HEATING

Make sure that all the necessary tests on the underfloor heating system have been completed before the flooring installation begins.

Installation

The working temperature (materials, subfloor and room air) during installation must be at least 15°C. As with installation where there is no underfloor heating, the relative humidity (RH) of the air must be between 30–60% before, during and after installation.

Note that a cold subfloor warms up slower than the room air.

Note that the requirement for movement joints at door openings is greater with underfloor heating because the floor moves more. Remember that a floor installed over underfloor heating is more vulnerable to moisture (high RH) than an unheated floor, because the floor's moisture content varies over a wider range.

A vapour barrier of an approved type is compulsory.



WHAT TO CONSIDER BEFORE INSTALLATION

Scheduling installation

Wood floors must not be laid until all other work, e.g. painting, wallpapering and tiling, is completed. The site must have the correct RH. This avoids contamination and moisture damage to the floor.

Installing floors is easier if architraves, etc., are fitted afterwards.

Storage

Wood flooring must be stored in an area where the RH is less than 60%. Do not open the packs of flooring until you are ready to install. Open the packs only when needed during installation.

Before installing a wood floor, ensure that the material has a minimum temperature of 15°C. It takes approximately two to three days storage in a heated location before the bundles reach the correct temperature. The temperature can be reached quicker if the floor packs are stacked in several small piles rather than a single pile. If the protective plastic has been damaged, repair it with tape to prevent moisture damaging the contents.

Installing boards in patterns

We recommend gluing to the substrate when the boards are to be laid in different directions in the same room. Floors with Woodloc® 5S joints cannot be installed with short ends against long sides.

Fixtures and fittings

Fixtures and fittings, kitchen island units, partitions, etc., must never be fixed to the parquet in a floating installation. They can be fixed through the floor provided a space is allowed, to prevent the fixed object from pressing down on and trapping the parquet. There must be a movement joint around the space.

Fix all the fixtures and fittings first, and then the floor. If the wood floor needs to be installed under the fixture or fitting for any reason, there must be a movement joint under the kickboard.

Modern kitchen units are normally fixed to the wall, with supporting legs at the front resting on the floor. This is generally of no significance to the floor. However, if the worktop is made of marble, granite or another heavy material, the legs should not rest on the floor to avoid trapping it.

If a wood-burning stove or similar is to stand on the floor, lay (e.g.) chipboard over an area slightly smaller than that of the "spark screen". This not only enables the floor to move freely but also makes it easier to replace boards near the stove if necessary. The chipboard also takes the weight of the stove. Remember to provide an expansion gap.

Planning floor installation

Measure the width of the room, and calculate the width of the last row of boards. If it is less 30 mm, you should also cut the first row of boards, to equalise the widths of the first and last rows. Remember to include an expansion gap.

When installing floors with Woodloc® 5S joints, it is easier if you start on the longest side of the room with most doors. If there are doors along the short side of the room, begin

each row of boards there. The boards can be installed from both left and right, as well as "backwards". If the area is geometrically complex, think carefully about the best method of installation, where you should begin laying and suitable places for expansion joints.

Plan carefully to avoid exceeding the maximum width (max 25 m for 15 mm multi-layer parquet with Woodloc® 5S and for 13 mm multi-layer flooring it is 15 m) and to ensure adequate skirting board dimensions.

Movement joints in wood floors

Natural seasonal variations cause a certain amount of movement (expansion and contraction) in wood floors.

This is why a floor must not be laid too close to adjacent walls or other fixed objects. A movement joint must be provided along each edge.

The floor must be able to expand at thresholds, door frames, heating pipes, pillars, stairs, tiled floors, other parquet flooring, etc. It is important to ensure that contraction caused by climate variations in winter will also be covered by the skirting board.

Gaps caused by contraction do not normally occur in floors with Woodloc® 5S joints, which is why all contraction manifests itself at the outer edges.

An expansion joint (movement joint) between two rooms/ floor areas can be concealed with a threshold.

Remember that the width of the expansion joint is the sum of the widths of the movement joints for each connecting area.

When wood floors are delivered their moisture content corresponds to approximately 40% RH.

The floor's RH normally varies seasonally between 30% and 60%. A wood floor must be able to move with the variation in moisture, which produces both expansion and contraction.

The size of the movement joint in mm is calculated using the formula: 1.5 mm x metre floor width.

A 4 m wide room should therefore have an expansion gap around the edge of $4 \times 1.5 \text{ mm} = 6 \text{ mm}$ between the floor and all fixed objects. For practical reasons, allowing a 10 mm movement joint for floors less than 6 m wide is convenient.

Graph shows: A wood floor's movements as it absorbs and emits moisture.

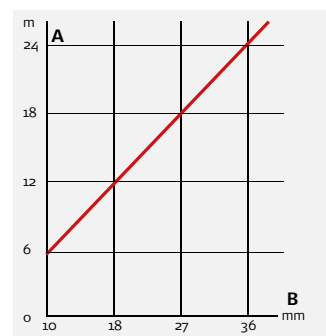

Note that the dimensions of the skirting board must never determine the size of movement joints. With large floor areas, the skirting board must therefore be selected on the basis of the required size for the expansion joint and not vice versa.

One solution for a situation that requires a large skirting board: In new buildings, a simple way of permitting additional floor movement is to "stop" wall panels immediately above the floor surface. If the wall panel is 13 mm plasterboard, for example, this provides an additional 13 mm movement allowance. This allows a thinner skirting board to be used than would otherwise be necessary.

Kährs Accessories range includes installation wedges that are easy to use and ensure a sufficient and accurate expansion gap.

Make sure that the floor does not go under the wall panel, e.g. plasterboard.

Various types of mouldings are available for achieving neat junctions (see www.kahrs.com).

Calculate the skirting board thickness

Make sure that the floor does not end up under the sheet!

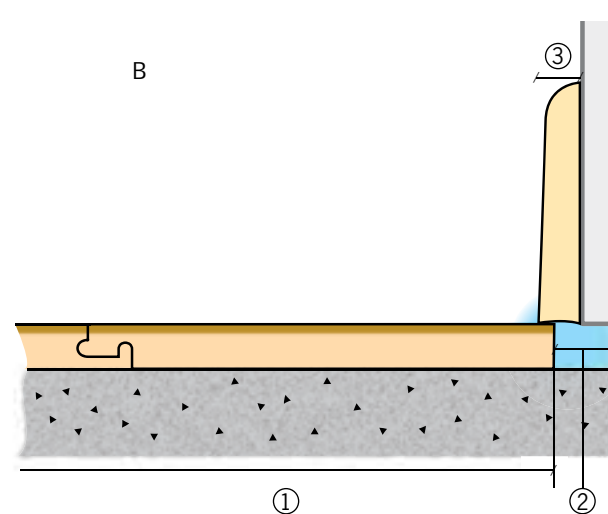
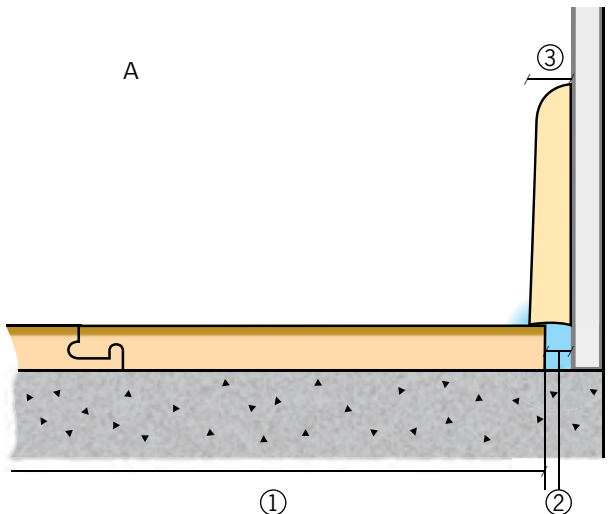

- 1. Floor width x 1.5 = expansion gap in mm.
- 2. Movement joint

- 3. Movement joint x 1.5 = skirting board minimum thickness in mm

Minimum skirting board thickness for various floor widths

Floor width 1	Movement joint 2	Cover allowance	Skirting thickness 3
4 m	6 mm	3 mm	15 mm*
6 m	9 mm	5 mm	15 mm*
8 m	12 mm	6 mm	18 mm
10 m	15 mm	7 mm	22 mm
12 m	18 mm	9 mm	27 mm
15 m	22 mm	11 mm	33 mm
18 m	27 mm	13 mm	40 mm

* Because a minimum 10 mm movement joint is recommended.

Uneven subfloors

If small depressions in the subfloor are noticed during floating installation, they can be filled using felt paper (max. 3 layers with underfloor heating). However, do not use more than one layer of Cellofloor or similar because it is excessively soft.

Choice of laying direction, max. widths

We recommend laying lengthways because boards move less along their length than across their width. In narrow areas, such as halls, it is particularly important that the boards lie flat against the subfloor.

Laying diagonally is more time-consuming but can be very eye-catching.

Remember that the maximum width (at right angles to the boards) must not be exceeded (max 25 m for 15 mm multi-layer parquet with Woodloc® 5S and for 13 mm multi-layer flooring it is 15 m). If the floor is wider than this, it must be divided (expansion joint). Take into account that the wastage will be a little higher (8–10%). Particular consideration must be given if the room does not have a simple geometric shape.

Cleaning the subfloor

Never leave sawdust or other organic residues on the subfloor. There is a high risk of mould if the space between the vapour barrier and the subfloor contains organic material and high humidity.

WHAT TO CONSIDER WHEN INSTALLING

Temperature and humidity conditions

The working temperature when laying should be at least 15°C. This applies both to the boards and to the room air. The relative humidity of the air must be between 30–60% before, during and after installation.

Opening packs

The wood floor is supplied "furniture dry". If packs are opened too early, the boards can absorb moisture and expand, which makes them difficult to fit together. If packs have been opened, they must be resealed carefully with tape to stop moisture getting in and adversely affecting the boards.

Inspection

It is always easier to rectify faults if they are discovered early. Always make a habit of inspecting the product at the time of installation. Faulty products can of course be exchanged with your supplier or ourselves. Boards with obvious faults that are detectable before installation must not be used. Always make sure that inspection and installation are carried out in good light. *Figure 1.*

End joints in small areas

Even small areas must be laid staggered, i.e. all floor areas must have end joints in every row. The end joints of adjoining rows must be staggered by at least 500 mm to ensure that the floor remains flat and level during climatic variations, otherwise there is a risk that the floor could bow in high relative humidity. *Figure 2.*

Gluing joints

Adhesive should not normally be used on boards with Woodloc® 5S joints. However, installation is sometimes easier if 1/3 of the locking edge is planed off and adhesive is applied to the horizontal underlip (see illustration). This means the board can be tapped into place. The joint will be sufficiently strong because of the wide area of adhesive. *Figure 3.*

Pattern misalignments

Minor pattern misalignments that occur during manufacturing are permitted in accordance with HusAMA

(the Swedish Building Regulation System – AMA Hus.

Pattern misalignment may occur with some floors such as those from the Marina Collection and Dutch pattern floors from the European Renaissance Collection. When laying boards with a Dutch pattern, the transverse strip must fit in the centre of the longitudinal strip on the adjoining row of boards.

Door openings

Floors installed through door openings or archways must be divided with an expansion gap which is then covered by a threshold or moulding. If an existing threshold is fixed to the subfloor, there must be a movement joint, of the same dimension as the other movement joints in the room, between the wood floor and the threshold. Note that there is a greater requirement for an expansion joint in door openings where underfloor heating is fitted. The threshold can also be removed, then refitted, when the floor has been laid with a joint under the threshold's position. If the threshold is too high, the door can be trimmed accordingly. Cutting the door is easier if you mark the cut line with tape and use a fine-toothed saw. *Figure 4.*

In some situations the flooring can be installed as one unit excluding the threshold or dilatation profile. This situation demands extra consideration and we recommend you to contact your dealer for advice.

Fitting skirting boards

The skirting boards must not press down on the wood floor, as they may trap it. Skirting boards can be fixed to walls using nails, screws or adhesive. Best results are achieved if the joints are mitred. Skirting boards must be adapted to suit the size of the movement joint.

Bowing

We aim to manufacture boards that are slightly convex lengthwise to make the floor easy to lay. A board that bows up to 20 mm can be installed without it affecting the finished floor. Do not forget to stagger the end joints in accordance with the installation instructions.

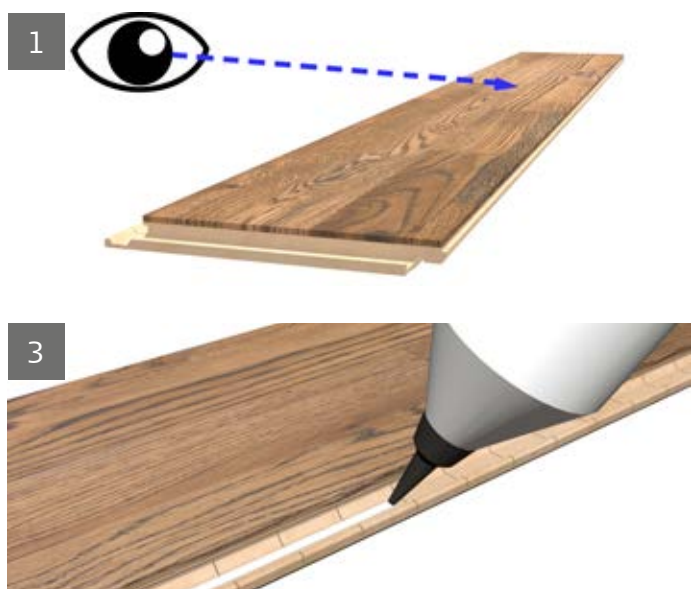

WHAT TO CONSIDER AFTER INSTALLATION

Spilt liquids must be wiped up immediately. This is particularly important for Beech and Hard Maple, because they move more than other species because of their greater sensitivity to moisture.

Supplementary surface treatment

We recommend to perform a first supplementary maintenance on oiled floors directly after installation. Use Kährs Satin Oil and follow the instructions on the package.

For more detailed information about care and maintenance, refer to our *Maintenance Guide brochure*, which can be downloaded at www.kahrs.com.

Protective covering

If further work is to be carried out in the room where the floor has been installed, the floor must be protected with a moisture permeable material (e.g. paper). Check that this will not discolour the floor. Note that some commonly used types of papers do not allow moisture to pass through, and have a wax coating that may be transferred to the wood floor. This causes undesirable gloss variations.

White goods do not usually have sufficiently large "wheels" to avoid causing damage if they are moved across the floor, in which case the floor requires much greater protection than protective paper alone.

Tape

Tape only to the protective covering, not to the wood floor. Many types of tapes stick to the floor so firmly that they lift the lacquer when removed. The longer the tape is left in place, the greater the risk of it adhering too strongly to the lacquer.

Kährs have selected tape which will prevent damages to the floorboard. Please contact your customer support for details.

Ventilation

When a floor is installed in a new building, ensure adequate ventilation to prevent building moisture damaging the floor. If the RH is higher than 60% there can be permanent deformation due, for example, to cellular collapse and/or laminate penetration.

Colour changes

Wood is a natural material that gradually matures to its natural colour, this happens most quickly to start with. To achieve an even surface, carpets should not be laid on the floor during the first few months after installation. If there are already light patches from carpets etc, they quickly mature when exposed to daylight.

More information on color changes for your specific product is available on our Technical data sheet, please contact customer support for more information.

INSTALLATION AND FITTING INSTRUCTIONS

Installation instructions for vapour barriers and intermediate layers

1. Plastic sheeting, 0.2 mm age-resistant polyethene sheeting, is used as a vapour barrier and must be laid with an overlap of at least 200 mm. It is supplied folded double. The plastic sheeting must be as close to the parquet as possible in the construction but beneath the intermediate layer. When installing with EPS, the vapour barrier must be placed under the insulation. Avoid walking on plastic sheeting once it has been laid.

Remember that organic material goes mouldy in a humid environment.

Never install 2 layers of vapor or moisture barrier with organic material in between, this will result in mould problems.

2. Felt paper (1 mm intermediate layer) must be laid with butt-jointed edges and must always be laid above the vapour barrier. It can be used to level out minor depressions in the subfloor (max. three layers with underfloor heating). It can also be used in strips as an intermediate layer for 20 mm flooring installed floating on battens.

3. Cellofloor, (3 mm polyethene foam intermediate layer) (30 kg/ m³), must be laid with butt-jointed edges. Cellofloor in strips is also an ideal intermediate layer for 20 mm flooring installed floating on battens. It must never be laid in more than one layer.

4. Kährs Tuplex, 3 mm polyethylene sheeting with polystyrene granules, is a combination underlay including moisture barrier with an overlap. Install the first sheet with the text side facing upwards and fold out the overlap.

Install the next sheet over the overlap with the sheet edges butt-jointed. This provides the moisture barrier function. If Kährs Tuplex has to be joined at the short ends, a 400 mm wide strip of 0.2 mm age-resistant polyethylene sheeting must be laid over the join to make it impervious. Kährs Tuplex installed in this way acts as both a vapour barrier and an intermediate layer. Kährs Tuplex must never be laid in more than one layer.

5. Kährs Special Underlay is an optimal 3-layer construction of high density and softness for excellent Drum Sound Reduction, by up to 25%, including a moisture barrier. The underlay is made of cross-linked polyethylene, polyolefin, minerals and a moisture barrier of polyethylene including a 60 mm overlap and a sealing tape. Install the first sheet with the black side facing upwards. Install the next sheet over the overlap with the sheet edges butt-jointed. Seal the joint with the pre applied tape. If Kährs Special Underlay has to be joined at the short ends, a 400 mm wide strip of 0.2 mm age-resistant polyethylene sheeting must be laid over the join to make it impervious. Kährs Special Underlay installed in this way acts as both a moisture barrier and an intermediate layer. Kährs Special Underlay must never be laid in more than one layer.

6. Kährs Protective Paper is laid with the film side facing down. Protective paper is used to protect the parquet against spillages and light wear after installation. Do not tape protective material to the wood floor. Greater protection must be provided if heavy items are to be moved across the floor, e.g. a refrigerator or freezer with small wheels. Clean the floor thoroughly before laying the protective paper. Look out for grit and sand which could be pressed down through the paper. The protective paper is biodegradable and can be recycled with other paper.

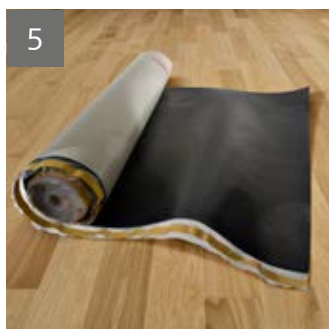
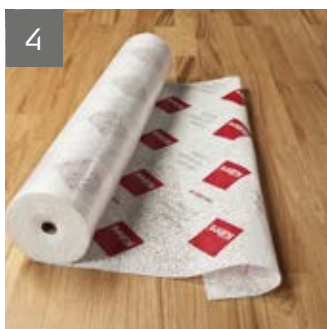
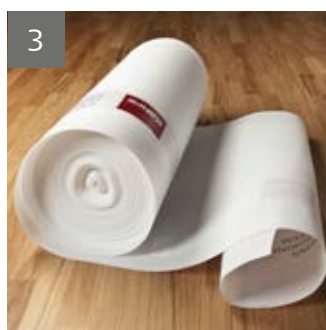

Using tools and accessories

1. Kährs Handblock for Woodloc 5s is used for installing boards with Woodloc® joints. Positioning the boards requires only light taps on their edges. Hold the tapping block lengthways against the edge of the board. Keeping one end in contact with the edge of the board, tap the board with the block. This applies the correct force, and the board will not be damaged.

2. Kährs locking tool tools are used to move the locking tongues into place in the last row, in order to lock the joints. The locking tool can also be used to lock the locking tongues when, for example, you want to replace a plank. For flooring thickness other than 15 mm, please use the relevant Kährs Locking Tool Adapter. *Figure 2b.*

3. Use a heel iron to tap the last row into place.

4. Kährs Adhesive for wood floors. An all-in-one, polyvinyl acetate-based adhesive used for traditional joints and in special circumstances with the Woodloc® joints. Must be stored out of the reach of children. Ensure good ventilation.

5. Use pairs of installation wedges (with "notches") to create a flexible space between the floor and adjacent surfaces when installing floor boards. Use two or more, depending on the size of the movement joint. Remove the wedges when installation is complete.

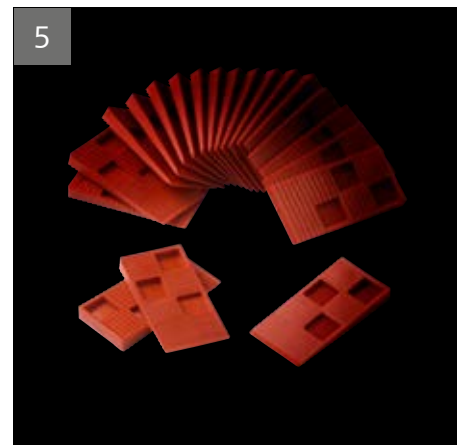
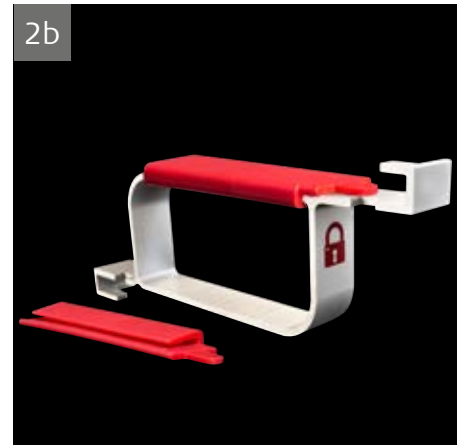

INSTALLATION INSTRUCTIONS FOR KÄHR'S WOOD FLOORS WITH WOODLOC® 5S JOINTS

Use Kährs installation tools.

Preparation

- If the installation requires a vapour barrier, do not forget it.
- First, calculate how many floor boards are required. If the last row is less than 30 mm wide, cut the first row, too. When installing floors with Woodloc® joints, it is easier if you start on the side with most doors. If there are doors along the short side of the room, begin each row of boards here. The boards can be installed from both left and right.
- The maximum width for 13 mm products is 15 m and for 15 mm products the maximum width is 25 m for Kährs wood floors with Woodloc® 5S joints. If the floor is wider, contact Kährs.

1. Begin in one corner, and work from left to right with the long underlip facing into the room. The gap between the long side and the wall can be adjusted once three rows have been laid. Start in a corner and lay the groove sides – the long under-lip – outwards into the rooms. Insert a wedge on the short side of the board. The distance from the long side to the wall can be adjusted later when three rows have been laid.

2. Angle the floorboards as shown in figure 2. Continue in the same way for the whole of the first row.

3. Cut the last board in the first row to the right length and start the next row with the piece left over. The board's end joints should be displaced by at least 500 mm during installation.

4-5. When assembling the floorboards the angle is important and should be approximately 20°. A maximum angle of 30° is recommended. When assembling the boards you start by positioning the board into the groove of the previous row.

Using an angle more than 30° might result in a bent or broken locking tongue and will jeopardize the function of the joint. An unlocked joint will result in proud edge in the short end joint of the board.

6. When the floorboard is delivered from the factory the locking tongue is aligned with the front edge of the top layer. However, if the locking tongue is moved during transportation or installation it might need to be manually repositioned.

7-8. Position the board using the correct angle (20-30°). Adjust the board into a position where the two short edges touch at the corner in accordance with the illustration. Make sure that the joint is free from dust or other particles.

9. Fold down the board into a position aligned with the surface of the previous board. If you can't do this without using excess force you need to remove the board and check the position of the locking tongue.

10-11. Tap lightly on the long side with the hammering block to ensure that it is in the correct position. The hammering block have been designed with a specific locking edge. Put your knee close to the joint and tap with a twisting movement and by doing so the locking tongue will be moved from unlocked to a locked position.

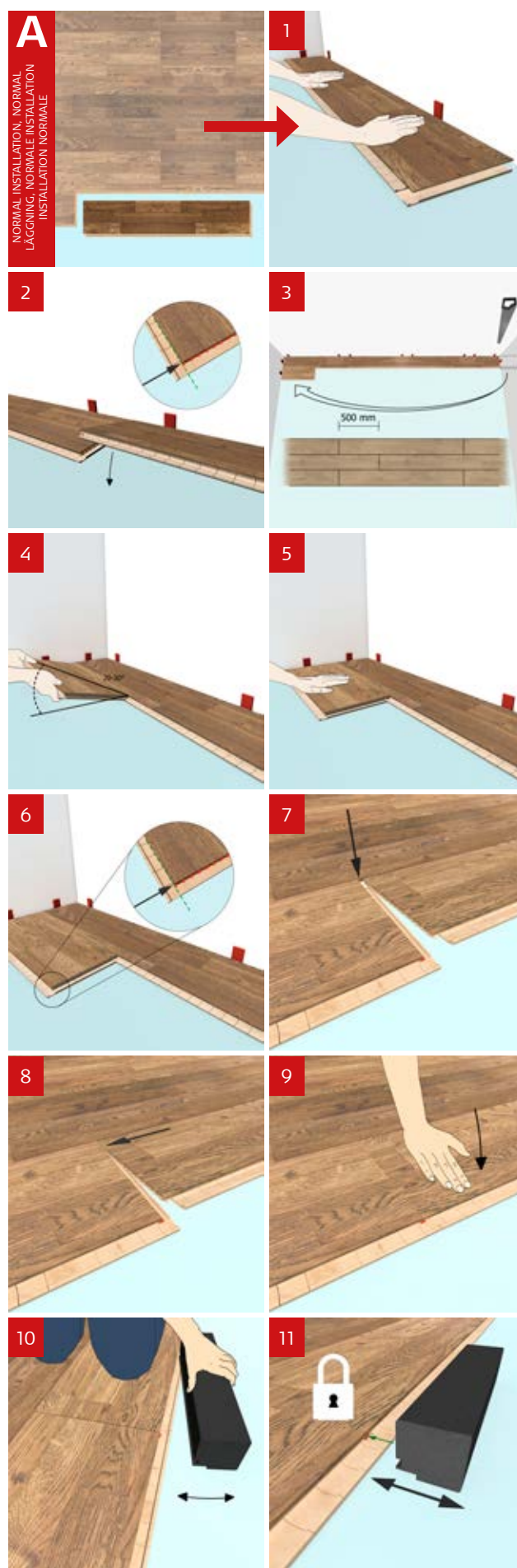

12. When three rows have been laid, the distance from the floor to the walls can be adjusted. Place wedges between the floor and wall.

13. The final board is then sawn to the correct width. Lay the final board on top of the penultimate board row with an approximate 5 mm displacement to the wall. Mark the section to be sawn using a piece of board with a locking strip. Lay it against the sawn board. Do the same with the next piece.

14. Work with tool horizontally

The last row must always be locked manually using the Kährs Locking Tool. For flooring thickness other than 15 mm, please use the relevant Kährs Locking Tool Adapter. Make sure that you position it correctly above the joint and use the correct side of the tool using the shortest tongue for locking. Move the tool towards you thereby successfully moving the locking tongue. Make sure that you maintain a horizontal position of the tool. Check the result and make sure the joint is successfully locked. When all locking tongues are in place, the floor row is locked. Now all that remains is to assemble the skirting boards. These must not be pressed down so that the floor is wedged fast. Bevel cover strips or T mouldings are used for transitions to other rooms.

If the tool is lifted from its horizontal position there is a risk of not successfully moving the locking tongue and thereby not locking the joint. This might later result in proud edges between boards.

The boards can be laid in any direction if required. Woodloc® 5S is also easy to take up. Use the locking tool (the long peg) in the same way as when locking the floor. Pull the tool towards you and the locking tongues will move to the unlocked position, making it easy for you to take the floor up.

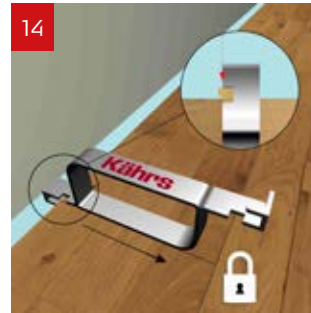
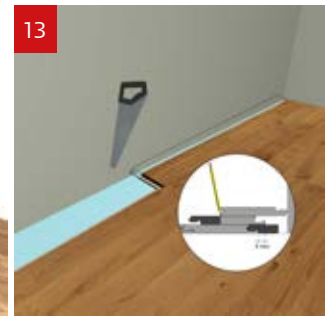

B 1-7. Reversed installation direction

Insert the first board into the locking strip. Keep the angle at approximately 20-30°.

Insert the second board into the locking strip. Slide the board so it fits with the short end of the first board. When joining the two short ends together you have to lift the short end of the first floor and slide the new board into connection. Continue with next row.

Tap lightly on the long side with the hammering block to ensure that it is in the correct position. The hammering block have been designed with a specific locking edge. Put your knee close to the joint and tap with a twisting movement and by doing so the locking tongue will be moved from unlocked to a locked position.

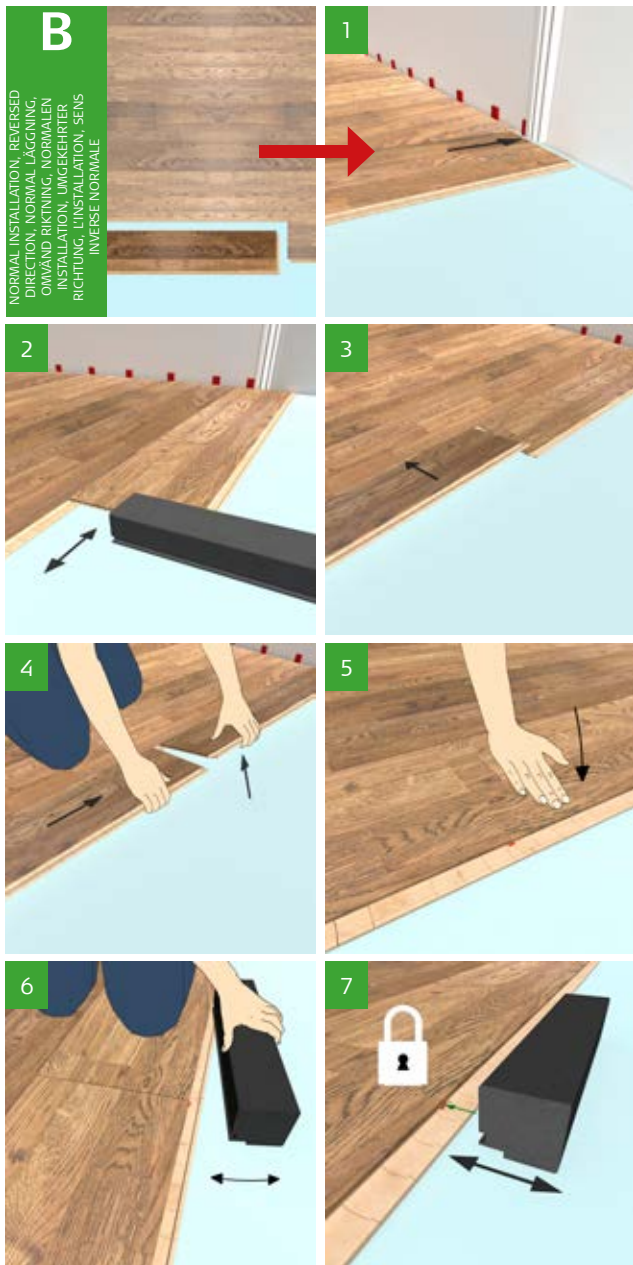

C 1-7. Backwards installation

When backwards installation is necessary, the locking tongue is shifted 5 mm to open position (see illustration). Lay the next board into position. Push in the locking tongue manually so that the marker triangle is aligned with the top layer to get into locked position. See figure 1-3

Insert the second board backwards fitting the tongue and groove. This must be done maintaining the correct angel of 20-30°.

Slide the board so it fits with the short end of the previous board. Fold down and tap lightly on the long side using the hammering block. Finish every short end joint by lightly tapping the locking tongue with the rear side of the block. See figure 4-7

NOTE! Ensure it is in locked position by carefully lifting up the board.

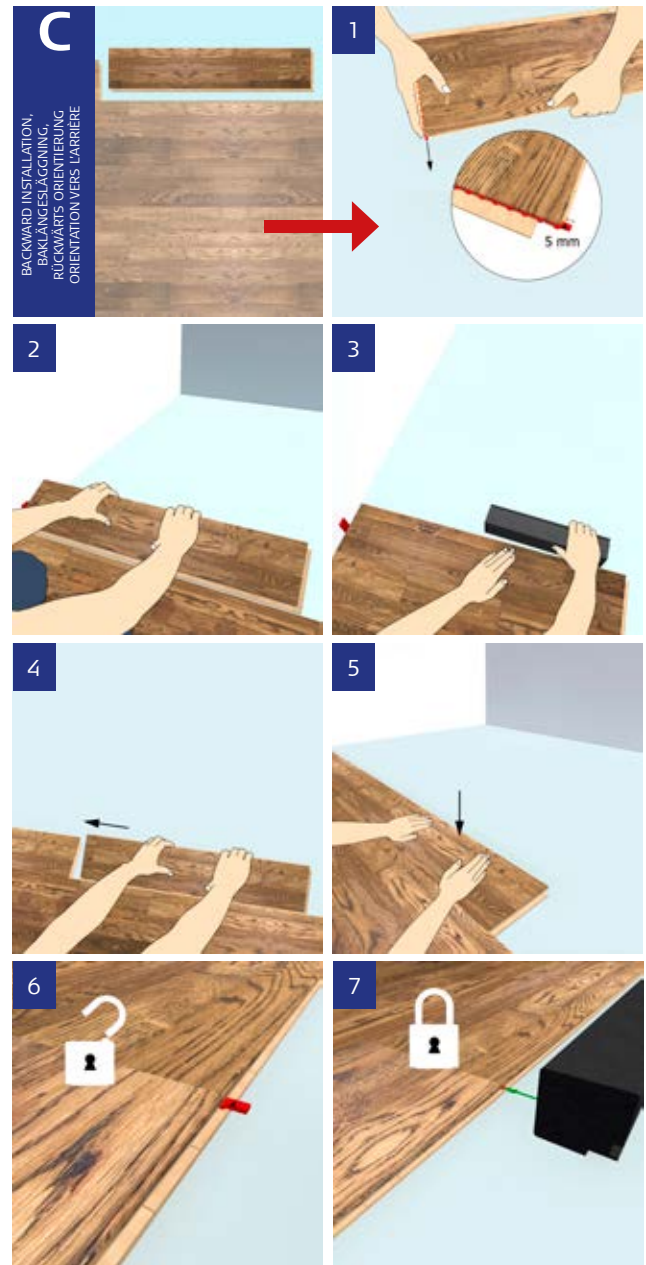

D 1-7. Backwards installation, reversed

When backward installation with reversed direction is required you install the first board by positioning it in the long side joint and tapping it into position using the hammering block. To install the following boards you first shift the locking tongue 5 mm before installing the board. When joining the two short ends together you have to lift the short end of the first floor and slide the new board into connection.

Work with the correct board angle 20-30°.

When the boards are joined you reposition the locking tongue using the rear side of the hammering block when pushing the tongue into it locked position.

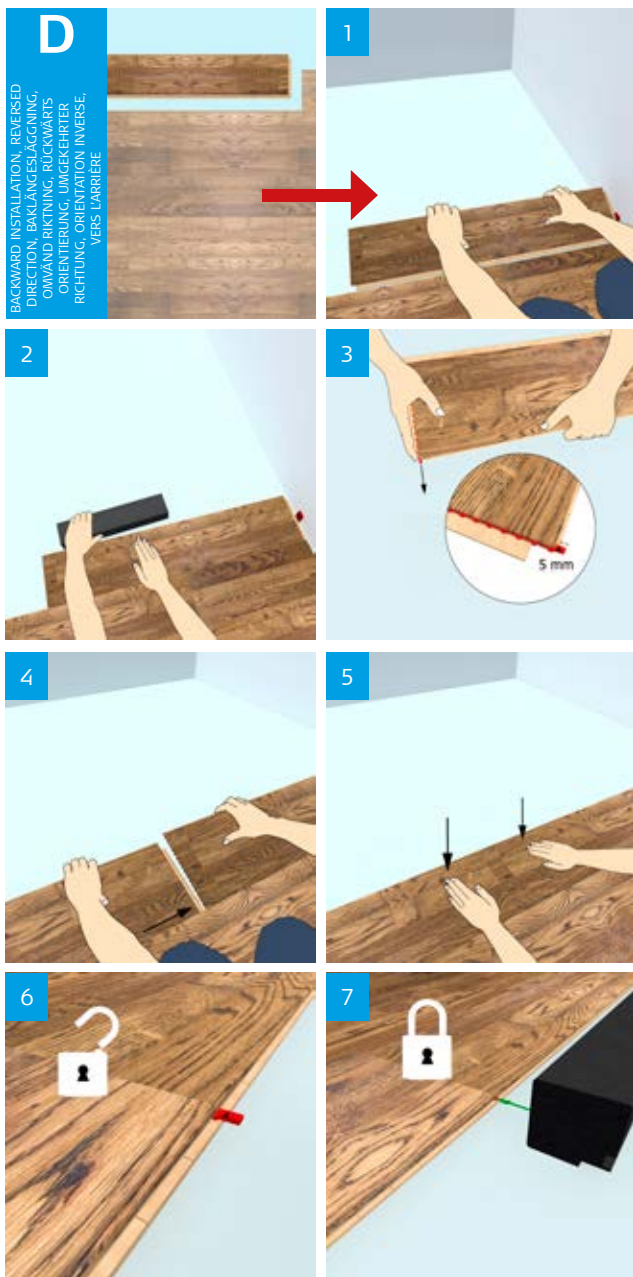

A few problems that are easy to solve.

A. Drill holes in the board to accommodate heating pipes. The holes must be at least 20 mm larger than the pipe's diameter. Make saw cuts as shown in the diagram. When the board is fitted, the sawn piece needs to be glued in place and the holes covered with pipe collars.

B. If you have to cut a door architrave, use a floorboard as a base so you get exactly the right height. If you need to knock a board along its length, protect the board's joint with a cut piece from a short end inserted into the joint.

C. Always begin each row of boards from a doorway. This makes it easier to push the prepared board under the frame. With Woodloc® 5S, the other boards in the row can be laid from either left or right.

D. When laying the board's short end against a door frame, the board needs to be adapted to the frame or the door architrave needs to be cut. Lay the board as close to the door frame as possible and then knock it in carefully from the short end. Protect the board using a cut piece (e.g. a suitable short end).

E. If you are unable to angle the board in at a door architrave, plane off 2/3 of the locking moulding. This allows you to tap the board into place. Apply adhesive to the underlip to avoid weakening the joint.

F. When installing under reveals it is often easiest to fit these boards before the return wall board is laid.

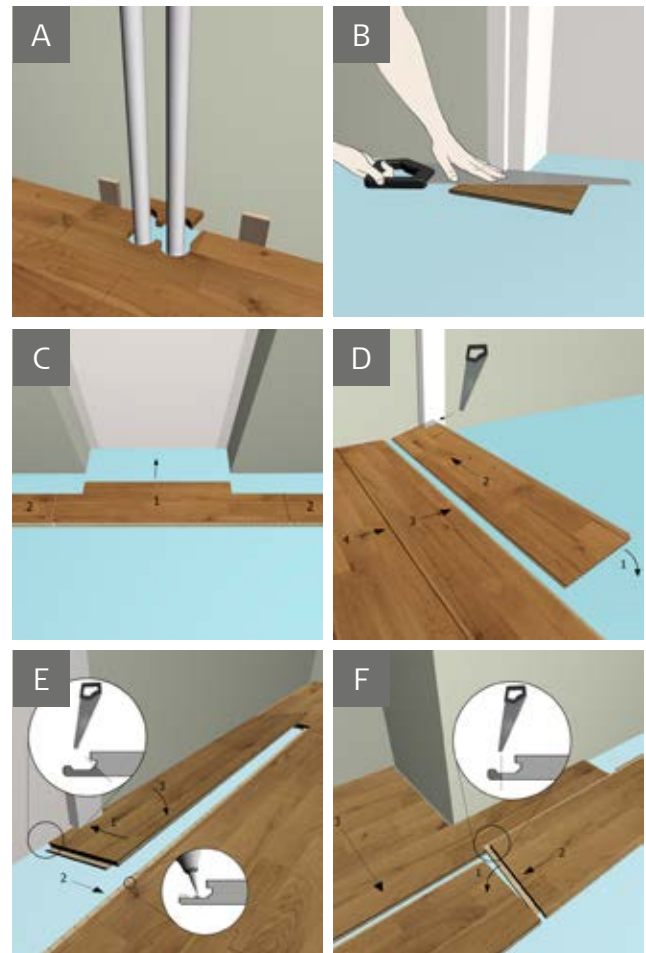

INSTALLATION INSTRUCTIONS FOR KÄHRS 15 MM ON 150 KPA EXPANDED FOAM, FLOATING, IN DOMESTIC ROOMS INSULATED WITH EPS

The foam sheets must comply with min. Group M, compression strength ≥ 150 kPa (density 30 kg/m^3). It is important that they are designed for this application and that they comply with the requirements for thickness tolerance and density. The density must be within $\pm 10\%$.

To avoid undesirable flexing of the finished floor, the thickness tolerance of the sheets must be ± 0.5 mm. For the same reason, bowed sheets must not be used.

Lay the foam sheets at right angles to the direction that the floor will be laid and stagger them so that there are no continuous joints running lengthways along the boards. The entire subfloor must be covered with foam sheets in such a

way that the boards are supported. Special attention must be given to pipe runs and door openings, etc. Reinforcement with timber battens may be required in some places. Follow the foam manufacturer's instructions. To prevent indentations, the foam sheets must be protected if they are to be walked on before the floor is installed.

Intermediate layer

An intermediate layer must be installed between the foam and the wood floor to avoid squeaks.

INSTALLATION INSTRUCTIONS FOR KÄHRS WOOD FLOOR ON 250 KPA EXPANDED FOAM, FLOATING, IN PUBLIC ENVIRONMENTS

The foam sheets must comply with at least Group T, compression strength ≥ 250 kPa (density 40 kg/m^3). It is important that they are designed for this application and that they comply with the requirements for thickness tolerance and density. The density must be within $\pm 10\%$.

To avoid undesirable flexing of the finished floor, the thickness tolerance of the sheets must be ± 0.5 mm. For the same reason, bowed sheets must not be used.

Lay the foam sheets at right angles to the direction that the floor will be laid, and stagger them so that there are no continuous joints running lengthways along the boards. The entire subfloor must be covered with foam sheets in such a way that the boards are supported. Special attention must be given to pipe runs and door openings, etc. Reinforcement with timber battens may be required in some places. Follow the foam manufacturer's instructions. To prevent indentations, the foam sheets must be protected if they are to be walked on before the floor is installed.

FIXING INSTRUCTIONS FOR WOOD FLOOR ACCESSORIES

Mouldings and trims

Used to cover movement joints, expansion joints, etc. Kährs offers complementary mouldings for most wood species. Details re. wood mouldings, and aluminium trims, are available at www.kahrs.com

Note the requirement for movement joints between the wood floor and level-, edge- and T-mouldings and surface-mounted nosings.

- Level mouldings are used for transitions to a lower level.
- Transition mouldings are used to cover expansion joints, etc.
- Edge mouldings are used to cover movement joints at balcony doors, etc.

Fixing mouldings and trims

Do not press the moulding or trim down too hard, otherwise the floor may become trapped or start to creak. For the same reason mouldings and trims should not be glued, screwed or nailed into or through the wood floor.

Nosings for Woodloc®

If nosing with Woodloc® is to be used, plan the installation so that the final board joint is in line with the edge of the top step to allow the nosing to be hooked into place. Adjust the position to create a movement joint. Glue the nosing where it adjoins the flat underlip. If this installation method is not possible, use nosings for traditional joints.

Nosings for traditional joints

Used when a Woodloc® nosing is not suitable. If the floor ends at right angles to the stair, or if the method of installation above is not possible, it may be necessary to cut the board and make a new groove in it. Cut the groove with a router using a 4.5 mm panel bit. Adjust the height carefully.

Spare tongues are included.



Instructions for supplementary products

1. Pipe collars are used to conceal movement joints at radiator pipes. The halves of the pipe collars are glued together around the pipe (see illustration). Size Ø 50 mm for 18 mm pipe.
2. Pipe roses are used to conceal movement joints round radiator pipes, etc. Measure where the hole should be and drill a hole for the pipe using a bit only slightly larger than the pipe. Use wood adhesive to glue the rosette halves together around the pipe (see illustration). Size 50 x 110 mm.
3. Woodfiller is used to fill small chips, etc. If a lot of filler is required, filling may need to be repeated because the filler may slump. Always use Touch-up Lacquer or Touch-up Oil depending on the floor's original surface treatment. Woodfiller is available in 11 different colours to suit the wood species.
4. Use Touch-up Lacquer (water-based) on UV-lacquered floors to repair minor damage and small scratches, and to

make-good repairs using Woodfiller. It has the same gloss value as satin lacquer and matt lacquer (30° and 10° Gardner, respectively). Glass bottle (30 ml) with brush. Protect from frost. Shelf-life at least one year from date of manufacture.

5. Touch-up Oil is used for repairing minor damage and small scratches on oiled floors and to make-good repairs using Woodfiller. It has the same gloss value as UV oil (10° Gardner). Glass bottle (30 ml) with brush.
6. Kährs Repair Kits, lacquer and oiled is a hot-melt wax solution used for small chips, etc. The kit contains heater, hard wax, spatula, felt-tip pen, Touch-up Lacquers and Touch-up Oils, plus instructions.
7. Kährs Repair Kit Pro is a hot-melt wax solution used for small chips, etc. The kit contains heater, hard wax, spatula, felt-tip pens, Touch-up Lacquers and Touch-up Oils, plus instructions.

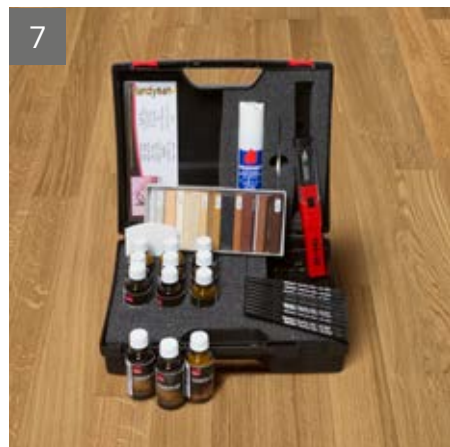

KÄHR'S POLICY ON FLAWS AND REJECTION OF MATERIAL DURING INSTALLATION

Should there be any doubt concerning quality, grading or visual defects, it is important that a claim must be filed prior to installing the flooring product. Installing a product will be considered as an acceptance of its delivery quality.

Gaps

The gap width may be a maximum of 0.2 mm when installing wooden flooring. However, within the warranty period, 2 x 1 mm wide gaps are permitted in a floor area of up to 30 m². With a larger area, the number of gaps permitted is in proportion to the specified area.

Height Difference

The height difference may be a maximum of 0.2 mm. However, a maximum of 5 individual height difference of up to 0.3 mm may occur in a floor area of up to 30 m². With a larger area, the number of height difference permitted is in proportion to the specified area.

Pattern flaws

Minor shifts in pattern, created during manufacture, are permitted between adjacent pattern boards.